

**AEROSUSA**

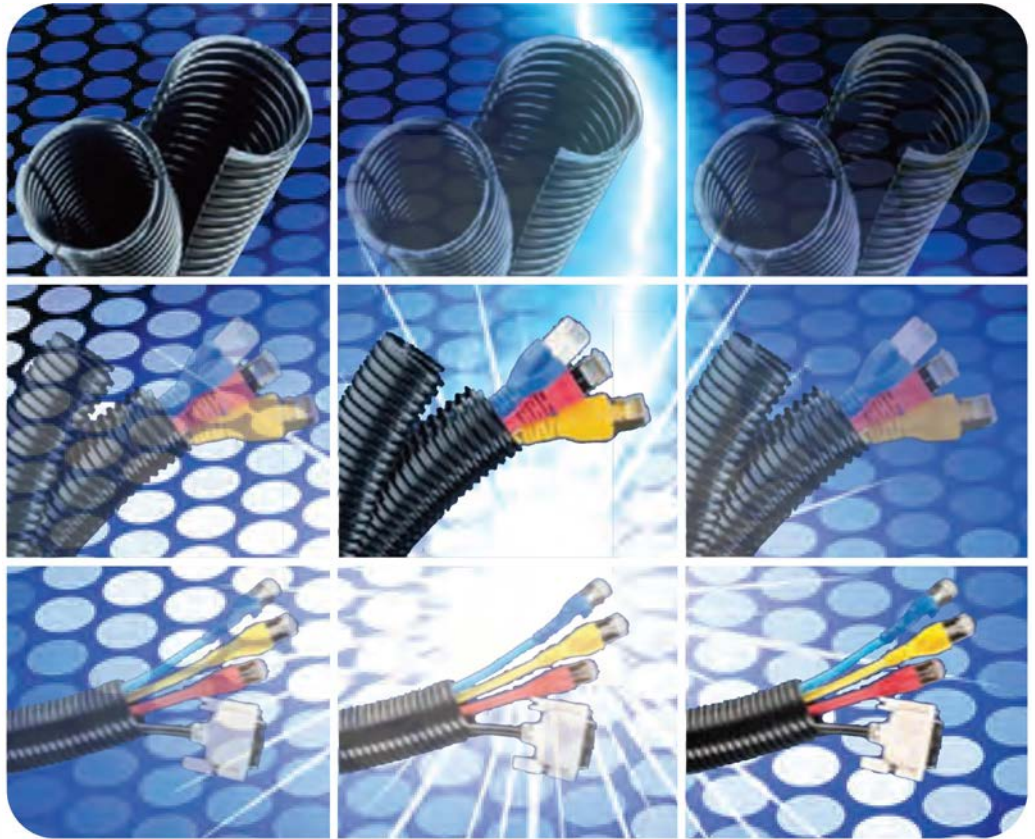

**Unsurpassed in Cable Protection & Strain Relief**

# Retrofitting Conduit





### Corrugated all-plastic tubing

Internally and externally corrugated, two-piece, longitudinal dividable and recloseable

#### Material

plastic [PA 6]

#### Properties

- good chemical resistance
- free of halogen, phosphor and cadmium
- self-extinguishing
- flame retardant
- flexible
- bending strength
- UV-resistant

Part No.	AD OD				
schwarz black	Ø	mm	mm	kg/m	m

0269.202.006	<b>10,0</b>	5,6 x 10,3	30	0,035	50
0269.202.008	<b>13,0</b>	8,5 x 13,3	35	0,045	50
0269.202.010	<b>15,8</b>	11,0 x 16,0	40	0,060	50
0269.202.014	<b>21,2</b>	15,1 x 21,3	55	0,080	50
0269.202.019	-	19,1 x 25,6	75	0,100	50
0269.202.020	<b>28,5</b>	21,9 x 28,5	95	0,120	50
0269.202.024	-	24,0 x 31,7	110	0,150	25
0269.202.026	<b>34,5</b>	27,2 x 35,0	120	0,170	25
0269.202.032	<b>42,5</b>	32,0 x 42,5	135	0,210	25
0269.202.043	<b>54,5</b>	43,9 x 53,9	140	0,230	25
0269.202.061	<b>79,0</b>	62,2 x 79,0	200	0,590	10

#### Small sales pack

0269.202.106	<b>10,0</b>	5,6 x 10,3	30	0,035	10
0269.202.108	<b>13,0</b>	8,5 x 13,3	35	0,045	10
0269.202.110	<b>15,8</b>	11,0 x 16,0	40	0,060	10
0269.202.114	<b>21,2</b>	15,1 x 21,3	55	0,080	10
0269.202.120	<b>28,5</b>	21,9 x 28,5	95	0,120	10
0269.202.126	<b>34,5</b>	27,2 x 35,0	120	0,170	5
0269.202.132	<b>42,5</b>	32,0 x 42,5	135	0,210	5
0269.202.143	<b>54,5</b>	43,9 x 53,9	140	0,230	5
0269.202.161	<b>79,0</b>	62,2 x 79,0	200	0,590	5

#### Application

- for retrofit and repair
- switch cabinet construction
- insulated electrical installations for application rules machine and plant constructions acc. to DIN EN 60204
- electrical installations

## V2 [UL 94]

🌡️ -40°C ... +135°C ^ ... +150°C

## ROHRflex® - Duo PP

### Corrugated all-plastic tubing

Internally and externally corrugated, two-piece, longitudinal dividable and recloseable

### Material

plastic [PP]

### Properties

- good chemical resistance
- free of phosphor and cadmium
- self-extinguishing
- flame retardant
- flexible
- UV-resistant



Part No.	AD OD				
black	∅	mm	mm	kg/m	m

0270.032.006	<b>10,0</b>	5,6 x 10,3	30	0,025	50
0270.032.008	<b>13,0</b>	8,5 x 13,3	40	0,035	50
0270.032.010	<b>15,8</b>	11,0 x 16,0	50	0,045	50
0270.032.014	<b>21,2</b>	15,1 x 21,3	65	0,060	50
0270.032.019	–	19,6 x 25,4	75	0,075	50
0270.032.020	<b>28,5</b>	21,6 x 28,1	80	0,095	50
0270.002.024	–	24,0 x 31,5	100	0,110	25
0270.032.026	<b>34,5</b>	26,8 x 34,4	110	0,140	25
0270.032.032	<b>42,5</b>	31,8 x 42,7	145	0,170	25
0270.032.043	<b>54,5</b>	43,9 x 53,9	150	0,220	25
0270.032.061	<b>79,0</b>	60,5 x 78,0	220	0,480	10

### Small sales pack

0270.032.106	<b>10,0</b>	5,6 x 10,3	30	0,025	10
0270.032.108	<b>13,0</b>	8,5 x 13,3	40	0,035	10
0270.032.110	<b>15,8</b>	11,0 x 16,0	50	0,045	10
0270.032.114	<b>21,2</b>	15,1 x 21,3	65	0,060	10
0270.032.120	<b>28,5</b>	21,6 x 28,1	80	0,095	10
0270.032.126	<b>34,5</b>	26,8 x 34,4	110	0,140	5
0270.032.132	<b>42,5</b>	31,8 x 42,7	145	0,170	5
0270.032.143	<b>54,5</b>	43,9 x 53,9	150	0,220	5
0270.032.161	<b>79,0</b>	60,5 x 78,0	220	0,480	5

### Application

- for retrofit and repair
- switch cabinet construction
- insulated electrical installations for application rules machine and plant constructions acc. to DIN EN 60204
- electrical Installations

## FLEXAzip

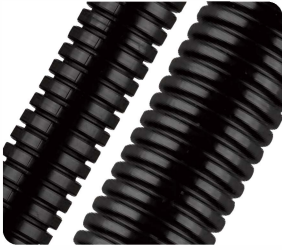





ROHRflex PA6  
corrugated all-nylon tubing

Self-closing  
slit for ease of retro-fit and  
additional installations

- HB acc. to UL 94
- ↓ -40°C ... +115° ^ +150°C











order no. FLEXAzip	conduit size					
black	Inch	OD	mm		kg/m	m
						
0255.202.110	5/8"	13.0	10,0 x 13,0	20	0,034	10
0255.202.112	3/4"	15.8	12,0 x 15,8	25	0,044	10
0255.202.116	1/2"	21.2	16,5 x 21,2	40	0,076	10
0255.202.123	3/4"	28.5	23,0 x 28,5	45	0,110	10
0255.202.129	1"	34.5	29,0 x 34,5	55	0,153	10
0255.202.136	1 1/4"	42.5	36,0 x 42,5	65	0,198	10
0255.202.148	1 1/2"	54.5	48,5 x 54,5	80	0,258	10



**Plastic connector**  
**straight, separable, outer thread**

Material: plastic [PA 6 mod.]

- to protect pre-assembled cables
- for retrospective installation or repairs
- simple assembly/disassembly
- IP 50 acc. to EN/IEC 60529



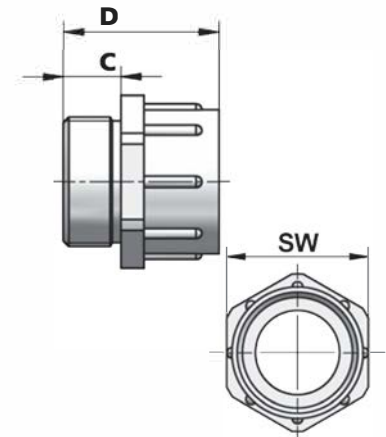

Part No.	AD OD								
black	∅	∅ I mm	∅ B mm	C mm	D mm	SW mm	kg/100	St. Pcs.	
<b>RQG-Duo-M</b>		<b>Metr. EN 60423</b>							
5128.015.216	<b>15,8</b>	<b>M 16 x 1,5</b>	11,0	30,0	15,0	30,0	26	0,750	10
5128.015.220	<b>15,8</b>	<b>M 20 x 1,5</b>	15,0	30,0	15,0	30,0	26	0,780	10
5128.021.220	<b>21,2</b>	<b>M 20 x 1,5</b>	15,0	32,0	15,0	30,0	28	0,850	10
5128.021.225	<b>21,2</b>	<b>M 25 x 1,5</b>	21,0	32,0	15,0	30,0	28	0,800	10
5128.028.225	<b>28,5</b>	<b>M 25 x 1,5</b>	21,0	40,0	15,0	35,0	36	1,300	10
5128.028.232	<b>28,5</b>	<b>M 32 x 1,5</b>	27,0	40,0	15,0	35,0	36	1,200	5
5128.034.232	<b>34,5</b>	<b>M 32 x 1,5</b>	27,0	50,0	15,0	35,0	46	2,400	5
5128.034.240	<b>34,5</b>	<b>M 40 x 1,5</b>	35,0	50,0	15,0	35,0	46	2,300	5
5128.042.240	<b>42,5</b>	<b>M 40 x 1,5</b>	35,0	62,0	15,0	35,0	55	2,800	5
5128.042.250	<b>42,5</b>	<b>M 50 x 1,5</b>	44,0	62,0	20,0	40,0	55	2,700	5
5128.054.250	<b>54,5</b>	<b>M 50 x 1,5</b>	44,0	72,0	20,0	45,0	65	3,300	5
5128.054.263	<b>54,5</b>	<b>M 63 x 1,5</b>	57,0	72,0	20,0	45,0	65	3,500	5



**Counternut**  
**for RQG-Duo-M, separable**

Material: plastic [PA 6 mod.]

- specifically for use in dividable cable protection systems
- simple assembly/disassembly

Part No.					
black	C mm	SW mm	kg/100	St. Pcs.	
<b>GMK-Duo-M</b>		<b>Metr. EN 60423</b>			
0318.000.016	<b>M 16 x 1,5</b>	10	26	0,160	10
0318.000.020	<b>M 20 x 1,5</b>	10	26	0,180	10
0318.000.025	<b>M 25 x 1,5</b>	10	28	0,200	10
0318.000.032	<b>M 32 x 1,5</b>	10	36	0,400	5
0318.000.040	<b>M 40 x 1,5</b>	12	46	0,900	5
0318.000.050	<b>M 50 x 1,5</b>	12	56	1,200	5
0318.000.063	<b>M 63 x 1,5</b>	12	71	1,850	5

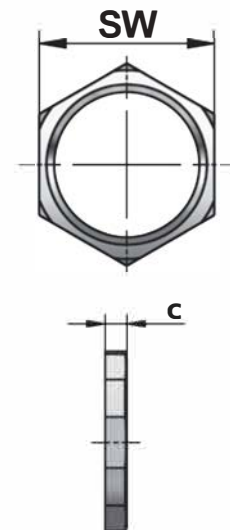

🌡️ -40°C ... +115°C

## Tubing clamp with cover

Material: plastic [PA]

- through hole for fastening by screws
- ribbed fixing for strain relief
- assembly of varying sizes joined in line
- for using in combination with C-profile bar



Part No.	AD		A	B	D	E	ø I	kg/100	St. Pcs.
	ø	OD							
<b>black</b>									
<b>RQHG</b>									
5030.028.207	10,0		19,5	19,0	13,0	15,0	5,5	0,400	50
5030.028.209	13,0		19,5	22,6	14,5	15,0	5,5	0,420	50
5030.028.211	15,8		21,5	25,4	16,1	15,0	5,5	0,460	50
5030.028.213	18,5		24,5	29,0	18,0	15,0	5,5	0,580	50
5030.028.216	21,2		26,5	33,0	21,0	15,0	6,5	0,660	50
5030.028.221	28,5		34,7	39,4	22,7	15,0	6,5	0,920	25
5030.028.229	34,5		40,0	44,4	26,0	15,0	6,5	1,080	25
5030.028.236	42,5		54,0	55,5	30,0	20,0	6,5	2,364	25
5030.028.248	54,5		65,0	69,0	37,3	20,0	6,5	3,200	10

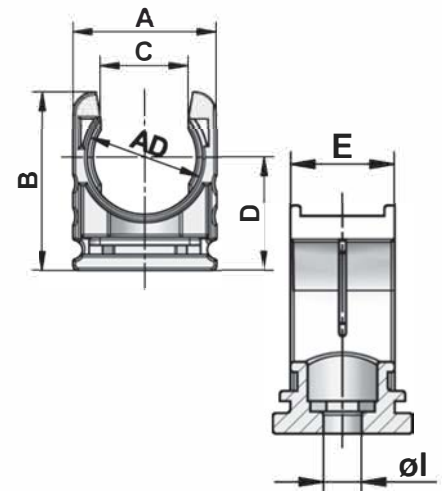

## One-piece tubing clamp

Material: plastic [PA]

- through hole for fastening by screws
- ribbed fixing for strain relief
- quick assembly by means of a filmhinge
- assembly of varying sizes joined in line
- for using in combination with C-profile bar



Part No.	AD		A	B	E	ø I	kg/100	St. Pcs.
	ø	OD						
<b>black</b>								
<b>RQS</b>								
5030.020.207	10,0		21,7	23,7	20,0	4,5	0,700	50
5030.020.209	13,0		26,0	29,0	20,0	5,5	0,920	50
5030.020.211	15,8		26,0	29,0	20,0	5,5	0,860	50
5030.020.213	18,5		32,5	37,0	20,0	5,5	1,240	50
5030.020.216	21,2		32,5	37,0	20,0	6,5	1,220	50
5030.020.221	28,5		43,3	50,4	20,0	6,5	1,800	25
5030.020.229	34,5		43,3	50,4	20,0	6,5	1,720	25
5030.020.236	42,5		65,0	77,0	20,0	6,5	3,120	25
5030.020.248	54,5		65,0	77,0	20,0	6,5	3,000	10

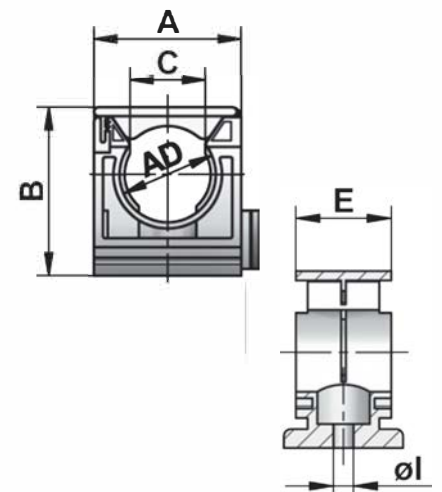

# ROHRflex<sup>®</sup>-Duo

## Mounting Instructions

Cables with plugs can be protected subsequently without any additional effort.



Ideal for retrofitting of cables and wires with mounted plugs



Divide the ROHRflex<sup>®</sup>-Duo and load the cables into the inner conduit ...



... Just close ROHRflex<sup>®</sup>-Duo by pressing the outer conduit over the inner conduit



Done. Fast and easy mounted and quickly dismantled

**AEROSUSA**

service@aerosusa.com  
717.238.1444  
2409 Herr St • Harrisburg, PA 17103



AERO.9.13

